

OUTLINE DIMENSIONAL DRAWING

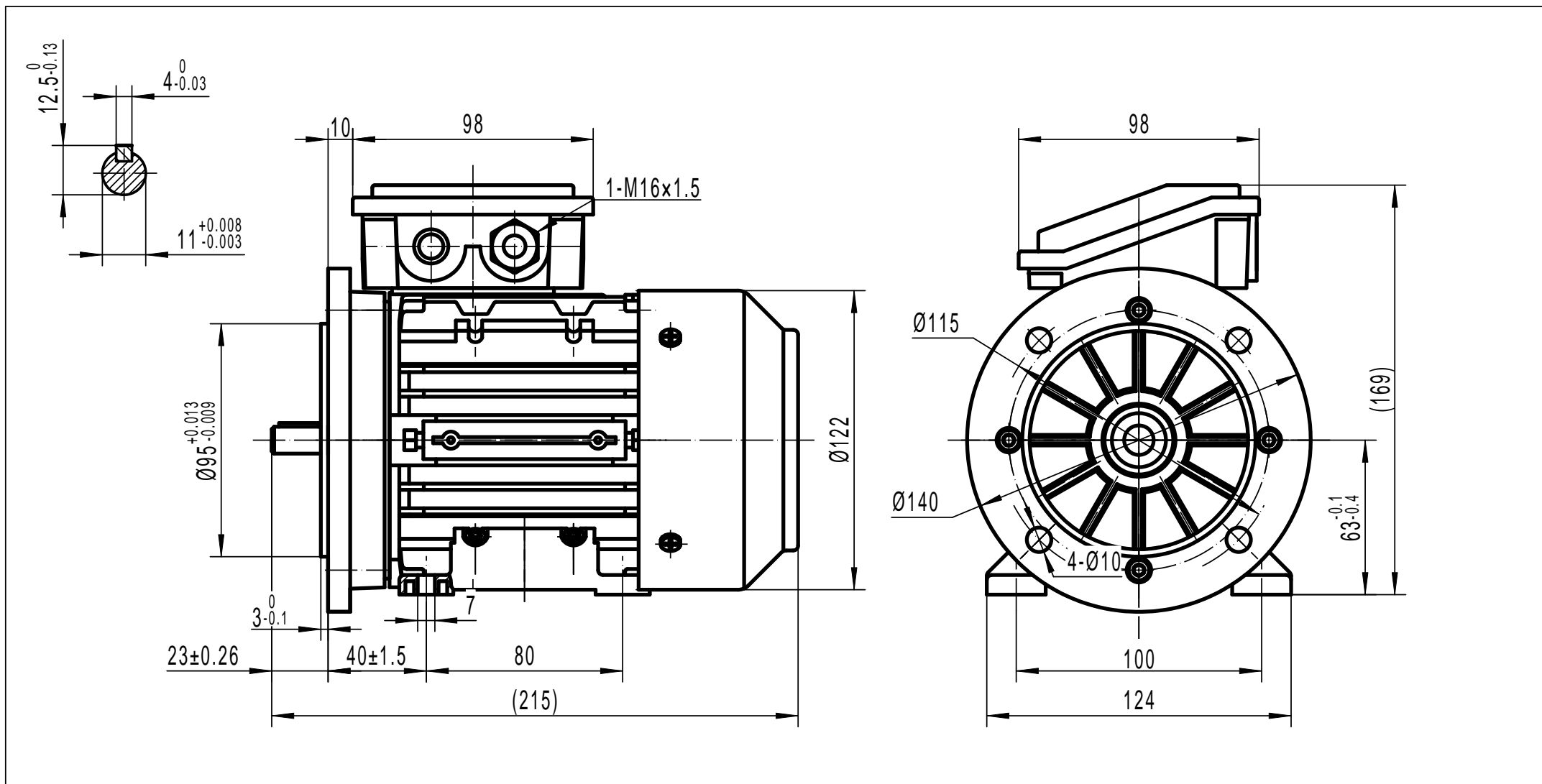

TECHTOP AUSTRALIA PTY LTD	
FRAME	TAI 63A B35
DATE	DRAWING NO.
2011/10/14	1ST081.051.001-010 A